

4 Install Screen Pad

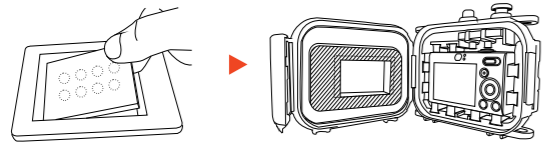

Choose the correct Screen Pad for thickness and screen size.

- Remove the appropriate block from the Screen Pad.
- Affix the Screen Pad to the rear housing.

3 Install Actuator Shafts

- Using the Mini Spanner tool, loosen the shutter actuator shaft.
- After placing the camera into the front housing, move the Hanging Clamp and Shutter Actuator Shaft to be directly over the shutter release button.
- Lock the Shutter Actuator Shaft in place.
- Check to make sure the Shutter Actuator Shaft position is correct.
- Make re-adjustments if required.
- Use the same procedure for the Power On/Off Actuator Shaft.

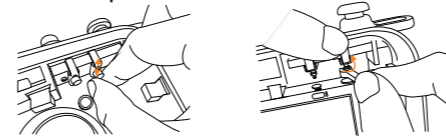

2 Install Round Type Cushions

- Insert the Round Cushions into the four cushion holders on the front housing.
- Please be sure that the Round Cushions are properly affixed.

Pre-Installation Preparation

Use the supplied Fish Tail Type Cushions, Round Type Cushions, and Screen Pads provided.

* Please refer to User Manual for detailed installation steps.

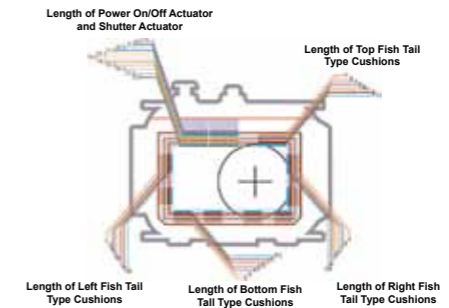

Use the Fitting Sheet (Cross Section Diagram) to help determine the size of the Fish Type Cushions and Actuator Shafts.

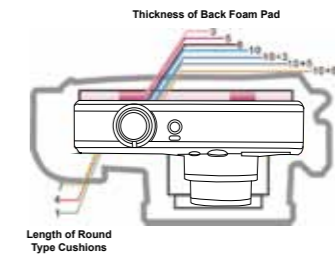

Use the Fitting Sheet (Top View Diagram) to help determine the length of the Round Type Cushions and Screen Pad.

Camera Preparation

- Turn the power of the camera to the "On" position.
- Set the camera to "Power Saving" mode, (if available).
- Set the camera to "Under Water" mode or "Auto" mode.
- Set the camera to Auto ISO or ISO400 or above.
- Set the camera to "Auto Review", (if required).
- Set the camera to the widest angle.
- Remove the camera strap.

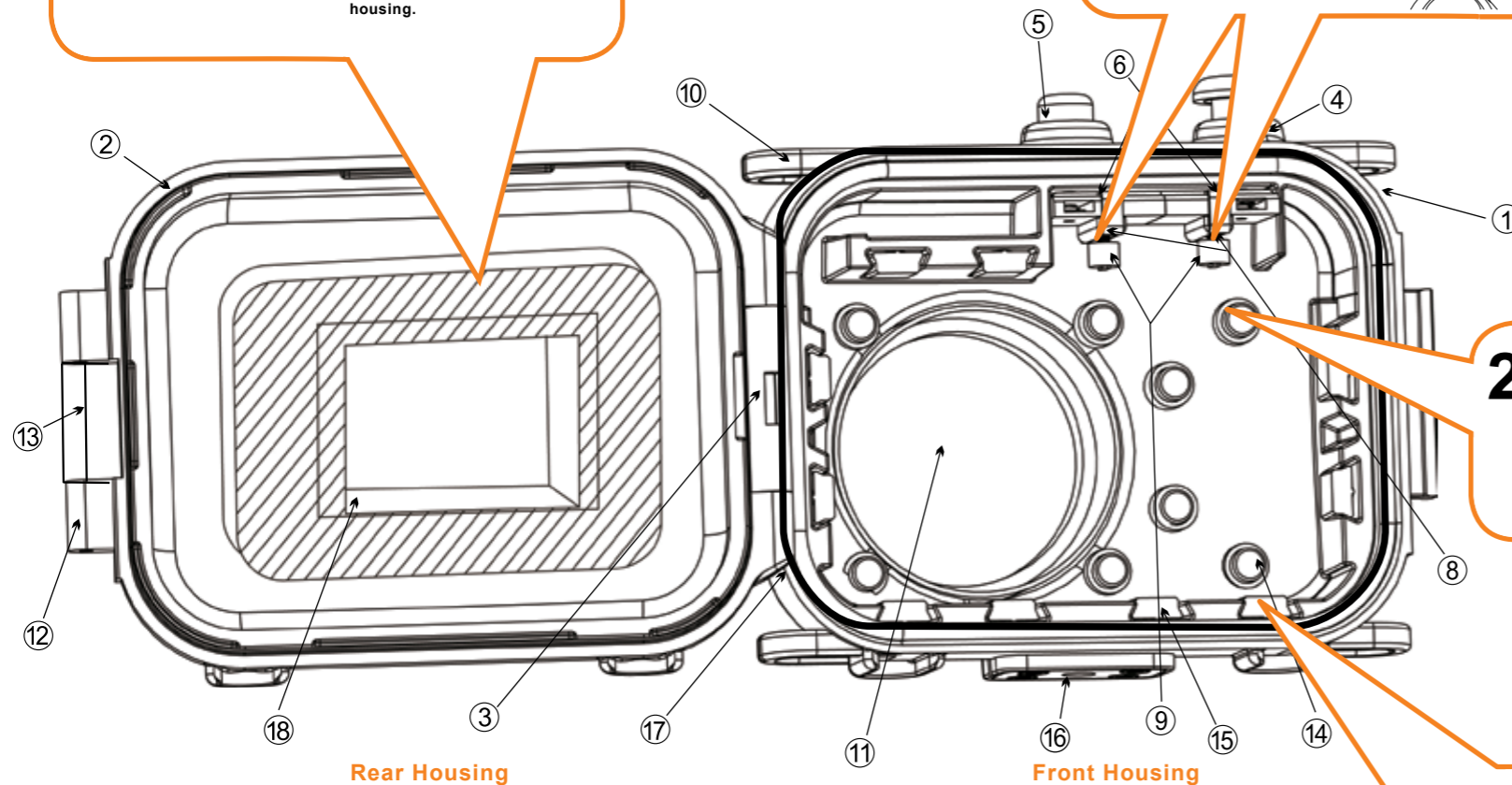
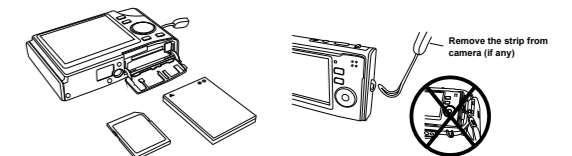

- | | | | |
|-----------------------|----------------------------------|---------------------|----------------|
| ① Front Housing | ⑥ Hanging Clamps | ⑪ Lens Window | ⑰ O-Ring |
| ② Rear Housing | ⑦ Water Sealing Lubricant Grease | ⑫ Lock | ⑱ Screen Pad |
| ③ Hingeavant | ⑬ Lock Button | ⑲ Neck Strap | ⑳ Hand Strap |
| ④ Shutter Button | ⑧ Actuator Shafts | ⑭ Fish Tail Cushion | ㉑ Mini Spanner |
| ⑤ Power On/Off Button | ⑩ Strip Mount | ⑮ Partie avant | |
| | | ⑯ Brace Hole | |

5 Test before Use

Installing Camera

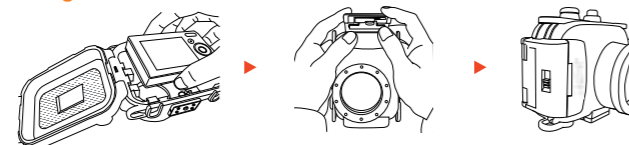

Load the camera into Seashell

Close the Seashell housing by flipping the lock

Test the lock by pulling the lock to see if it is secured

Test the Operation of the Camera

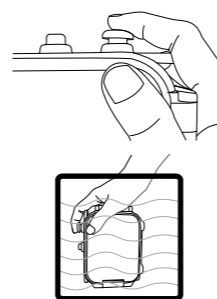

- Close the Seashell camera case without the camera installed .
- Submerge the Seashell to a depth of 200mm for at least 5 minutes to ensure there is no water leak.
- Insert the camera into the Seashell.
- Close the housing by flipping the lock.
- Test the lock by pulling on the latch to see if it is secured.
- Check the operation of the camera.

Illustration of Seashell SS-1 are used for the "Quick Setup Guide" purpose. The operational procedures are the same for the Seashell SS-2.

Please refer to the User Manual for detailed installation steps.
* Before operating or adjusting this product, please read the entire User Manual.